

DAEWOO

MICROWAVE OVEN

KOR-63RA

OPERATING INSTRUCTIONS
& COOK BOOK

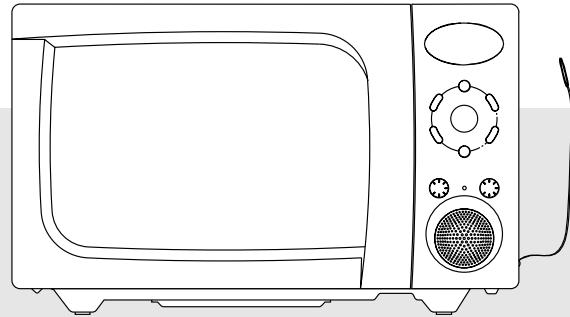

Helpline number: 01189 252627

Before operating this oven, please read these instructions completely.

PRECAUTIONS TO AVOID POSSIBLE EXPOSURE TO EXCESSIVE MICROWAVE ENERGY

- (a) **Do not attempt to operate this oven with the door open** since open-door operation can result in harmful exposure to microwave energy. It is important not to defeat or tamper with the safety interlocks.
- (b) **Do not place any object** between the oven front face and the door or allow soil or cleaner residue to accumulate on sealing surfaces.
- (c) **WARNING** : If the door or door seals are damaged, the oven must not be operated until it has been repaired by a trained person : (1) door (bent), (2) hinges and latches(broken or loosened), (3) door seals and sealing surfaces.
- (d) **WARNING** : It is hazardous for anyone other than a trained person to carry out any service or repair operation which involves the removal of any cover which gives protection against exposure to microwave energy.
- (e) **WARNING** : Liquids or other foods must not be heated in sealed containers since they are liable to explode.
- (f) **WARNING** : Only allow children to use the oven without supervision when adequate instructions have been given so that the child is able to use the oven in a safe way and understands the hazards of improper use.

TABLE OF CONTENTS

PRECAUTIONS	1
IMPORTANT SAFETY INSTRUCTIONS	2
EARTHING INSTRUCTIONS	3
INSTALLATION	3
SPECIFICATIONS	4
IMPORTANT	4
FEATURES DIAGRAM	5, 6
OPERATION PROCEDURE	7
CONTROLS	8
SETTING THE CLOCK	8
WEIGHT DEFROSTING	8
TIME DEFROSTING	9
COOKING IN ONE STAGE	10
EASY COOKING	11
AUTO COOK	11
RADIO	12
CHILD SAFETY LOCK	13
TO STOP THE OVEN WHILE THE OVEN IS OPERATING	13
COOKING INSTRUCTIONS	14
USE YOUR MICROWAVE OVEN SAFELY	15
CARE AND CLEANING	15
MICROWAVING PRINCIPLES	16
HOW MICROWAVES COOK FOOD	16
CONVERSION CHARTS	16
COOKING TECHNIQUES	17
DEFROSTING GUIDE	18
DEFROSTING CHART	19
COOKING & REHEATING CHART	20
VEGETABLE CHART	21
BEFORE YOU CALL FOR SERVICE	26
QUESTIONS AND ANSWERS	26



IMPORTANT SAFETY INSTRUCTIONS

WARNING : To prevent fire, burns, electric shock and other warnings:

Listed below are, as with all appliances, certain rules to follow and safeguards to assure high performance from this oven:

1. Do not use the oven for any reason other than food preparation, such as for drying clothes, paper, or any other nonfood items or for sterilizing purposes.
2. Do not use the oven when empty, this could damage the oven.
3. Do not use the oven cavity for any type of storage, such as papers, cookbook, cookware, etc.
4. Do not operate the oven without the glass tray in place. Be sure it is properly sitting on the rotating base.
5. Make sure you remove caps or lids prior to cooking when you cook food sealed in bottles.
6. Do not put foreign material between the oven surface and door. It could result in excessive leakage of microwave energy.
7. Do not use recycled paper products for cooking. They may contain impurities which could cause sparks and/or fires when used during cooking.
8. Do not pop popcorn unless popped in a microwave approved popcorn popper or unless it's commercially packaged and recommended especially for microwave ovens.
Microwave popped corn produces a lower yield than conventional popping; there will be a number of unpopped kernels. Do not use oil unless specified by the manufacturer.
9. Do not cook any food surrounded by a membrane, such as egg yolks, potatoes, chicken livers, etc., without first piercing them several times with a fork.
10. Do not pop popcorn longer than the manufacturer's directions. (popping time is generally below 3 minutes).
Longer cooking does not yield more popped corn, it can cause scorchings and fire.
Also, the cooking tray can become too hot to handle or may break.
11. If smoke is observed, switch off or unplug the appliance and keep the door closed in order to stifle any flames.
12. When heating food in plastic or paper containers, check the oven frequently due to the possibility of ignition.
13. The contents of feeding bottles and baby food jars are to be stirred or shaken and the temperature is to be checked before consumption, in order to avoid burns.
14. Always test the temperature of food or drink which has been heated in a microwave oven before you give it to somebody, especially to children or elderly people. This is important because things which have been heated in a microwave oven carry on getting hotter even though the microwave oven cooking has stopped.
15. Eggs in their shell and whole hard-boiled eggs shall not be heated in microwave ovens since they may explode.
16. Keep the waveguide cover clean at all times. Wipe the oven interior with a soft damp cloth after each use. If you leave grease or fat anywhere in the cavity it may overheat, smoke or even catch fire when next using the oven.
17. Never heat oil or fat for deep frying as you cannot control the temperature and doing so may lead to overheating and fire.
18. Microwave heating of beverages can result in delayed eruptive boiling, therefore care has to be taken when handling the container.

SAVE THESE INSTRUCTIONS

ARCING

*If you see arcing, press **STOP/CLEAR** button and correct the problem.*

Arcing is the microwave term for sparks in the oven. Arcing is caused by:

- Metal or foil touching the side of the oven.
- Foil not molded to food (upturned edges act like antennas).
- Metal, such as twist-ties, poultry pins, or gold rimmed dishes, in the microwave.
- Recycled paper towels containing small metal pieces being used in the microwave.

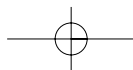

EARTHING INSTRUCTIONS

This appliance must be earthed. In the event of an electrical short circuit, earthing reduces the risk of electric shock by providing an escape wire for the electric current. This appliance is equipped with a cord having a earthing wire with a earthing plug. The plug must be plugged into an outlet that is properly installed and earthed.

WARNING : Improper use of the earthing plug can result in a risk of electric shock. Consult a qualified electrician or serviceman if the earthing instructions are not completely understood, or if doubt exists as to whether the appliance is properly earthed. If it is necessary to use an extension cord, use only a 3-wire extension cord that has a 3-blade earthing plug, and a 3-slot receptacle that will accept the plug on the appliance. The marked rating of the extension cord should be equal to or greater than the electrical rating of the appliance.

INSTALLATION

1 Steady, flat location

This oven should be set on a steady, flat surface. This oven is designed for counter top use only.

2 Leave space behind and side

All air vents should be kept a clearance. If all vents are covered during operation, the oven may overheat and, eventually, oven failure.

3 Away from radio and TV sets

Poor television reception and radio interference may result if the oven is located close to a TV, Radio antenna, feeder and so on. Position the oven as far from them as possible.

4 Away from heating appliance and water taps

Keep the oven away from hot air, steam or splash when choosing a place to position it, or the insulation might be adversely affected and breakdowns occur.

5 Power supply

- Check your local power source. This oven requires a current of approximately 6 amperes, 230V 50Hz.
- Power supply cord is about 0.8 meters long.
- The voltage used must be the same as specified on this oven. Using a higher voltage may result in a fire or other accident causing oven damage. Using low voltage will cause slow cooking. We are not responsible for damage resulting from use of this oven with a voltage of ampere fuse other than those specified.
- If the supply cord is damaged, it must be replaced by the manufacturer or its service agent or a similarly qualified person in order to avoid a hazard.

6 Examine the oven after unpacking for any damage such as:

A misaligned door, Broken door, A dent in cavity. If any of the above are visible, DO NOT INSTALL, and notify dealer immediately.

7 Do not operate the oven if it is colder than room temperature.

(This may occur during delivery in cold weather.) Allow the oven to become room temperature before operating.

8 The minimum height of free space necessary above the top surface of the oven is 100mm.

SPECIFICATIONS

POWER SUPPLY		230V~ / 50Hz, SINGLE PHASE WITH EARTHING
MICROWAVE	POWER CONSUMPTION	1200 W
	OUTPUT POWER	800 W
	FREQUENCY	2450 Mhz
FM RADIO	FREQUENCY RANGE	87.5Mhz ~ 108Mhz
	SPEAKER	4ohm, 0.5 W
OUTSIDE DIMENSIONS (W X H X D)		465 X 279 X 375 mm
CAVITY DIMENSIONS (W X H X D)		290 X 220 X 306 mm
NET WEIGHT		APPROX. 12KG
TIMER		59 min. 00sec.
POWER LEVELS		5 LEVELS

* Specifications are subject to change without notice.

IMPORTANT

The wires in this mains lead fitted to this appliance are coloured in accordance with the following code.

Green-and-yellow : Earth
 Blue : Neutral
 Brown : Live

As the colours of the wires in the mains lead of this appliance may not correspond with the coloured markings identifying the terminals in your plug, proceed as follows: the wire which is coloured green-and-yellow must be connected to the terminal in the plug which is marked with the letter 'E', the earth symbol or coloured green-and-yellow. The wire which is coloured blue must be connected to the terminal which is marked with the letter 'N' or coloured black.

The wire which is coloured brown must be connected to the terminal which is marked with the letter 'L' or coloured red.

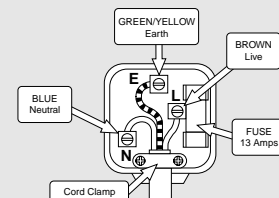

WARNING: This appliance must be earthed.

FEATURES DIAGRAM

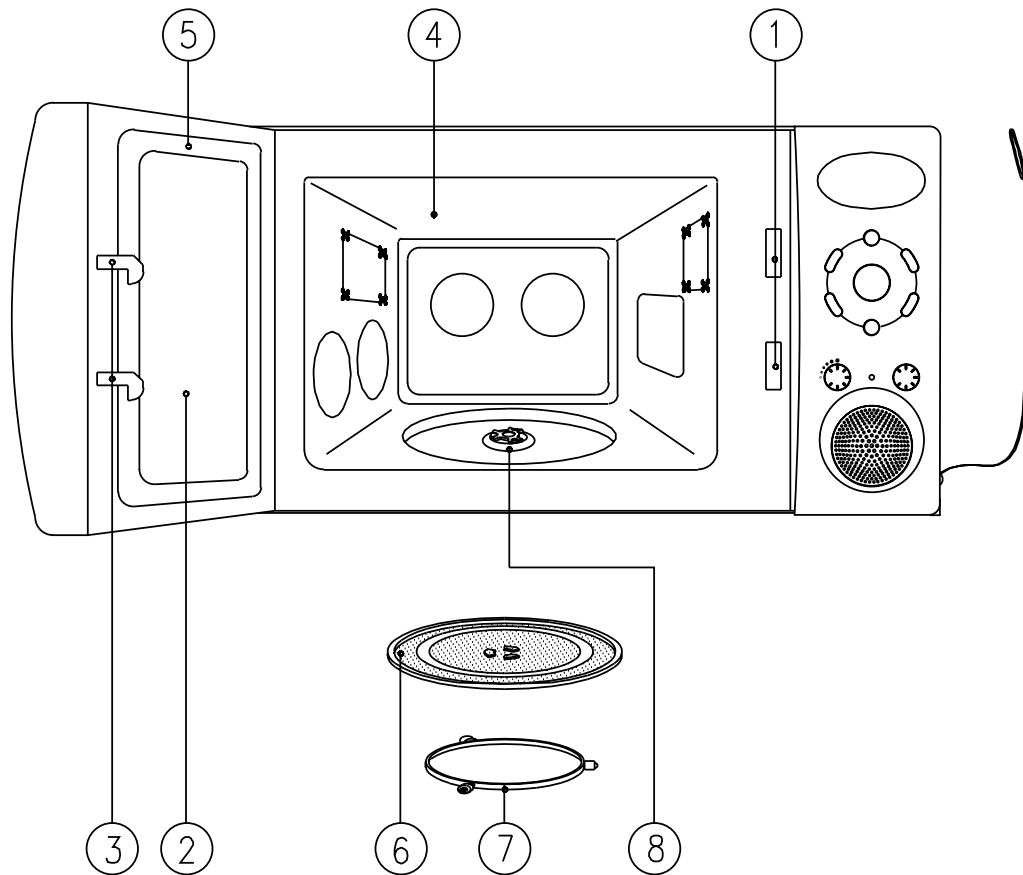

- ① **Safety interlock system**-Prevents the oven from operating while the door is opened. The oven will only operate with the door fully closed. When the door is open, the oven turns off and will only start again after the door is closed.
- ② **Door screen**-Allows viewing of food. The screen is transparent to light, but prevents microwaves escaping.
- ③ **Door latch**-When the door is closed it will automatically shut off. If the door is opened while the oven is operating, the magnetron will automatically shut off.
- ④ **Oven cavity**
- ⑤ **Door seal**-The door seal surfaces prevent microwaves escaping from the oven cavity.
- ⑥ **Glass cooking tray**-Made of special heat resistant glass. The tray can be easily removed for cleaning. Make sure it is correctly positioned (indentation) before operating. Place food in a suitable container (dish) on the tray.
- ⑦ **Roller guide**-Supports the glass cooking tray.
- ⑧ **Coupler**-This fits over the shaft in the center of the oven's cavity floor. This is to remain in the oven for all cooking.

FEATURES DIAGRAM (continued)

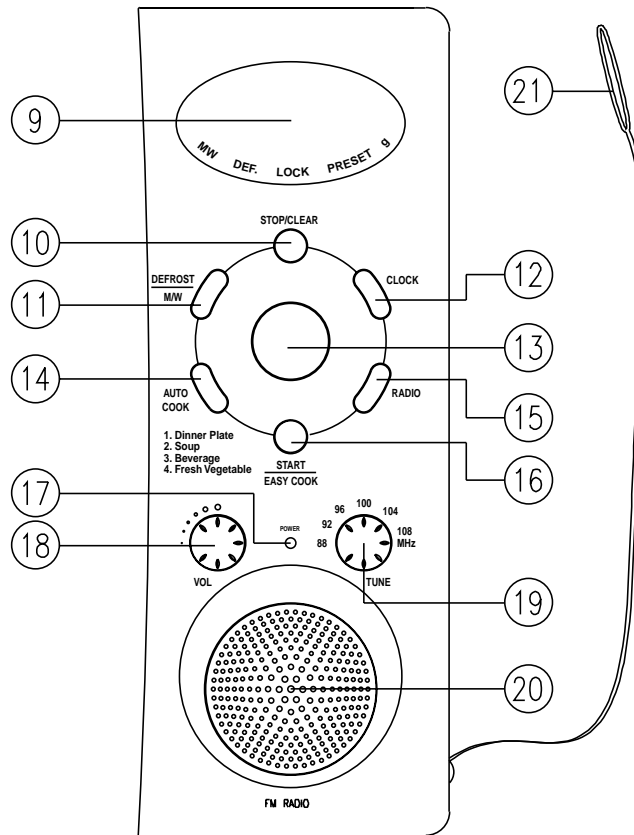

- ⑨ **DISPLAY**- Cooking time, power level, indicators and present time are displayed.
- ⑩ **STOP/CLEAR**- Used to stop the oven operation or to erase all entries.
- ⑪ **DEFROST/MW**- Used to set the power level and used to defrost foods by weight or time.
- ⑫ **CLOCK**- Used to set the clock.
- ⑬ **DIAL KNOB**- Used to set the time and the weight.
- ⑭ **AUTO COOK**- Used to cook and to reheat according to the programmed procedure.
- ⑮ **RADIO**- Used to listen to FM radio broadcasts.
- ⑯ **START/EASY COOK**-Used to start the oven operation and also increase cooking time by 30 seconds.
- ⑰ **POWER LED**- If RADIO function is selected, this lamp will be turned on.
- ⑱ **VOLUME KNOB**- Used to turn the sound of the speaker up or down.
- ⑲ **TUNING KNOB**- Used to tune stations.
- ⑳ **SPEAKER**
- ㉑ **FM ANTENNA**

OPERATION PROCEDURE

This section includes useful information about oven operation.

1. Plug power supply cord into a 230V 50Hz power outlet.
2. After placing the food in a suitable container, open the oven door and put it on the glass tray.
The glass tray and roller guide must always be in place during cooking.
3. Shut the door. Make sure that it is firmly closed.
 - 1 The oven light is on only when the microwave oven is operating.
 - 2 The oven will automatically shut off at any time by opening the oven door.
 - 3 Each time a button is pressed, a BEEP will sound to acknowledge the touch.
 - 4 The oven automatically cooks on full power unless set to a lower power level.
 - 5 The display will show “ : 0” when the oven is plugged in.
 - 6 The time clock returns to the present time when the cooking time ends.
- 7 When the STOP/CLEAR button is pressed during the oven operation, the oven stops cooking and all the information is retained. To erase all information (except the present time), touch the STOP/CLEAR button once more. If the oven door is opened during the oven operation, all information is retained.
- 8 If the START button is pressed and the oven does not operate, check the area between the door and door seal for obstructions and make sure the door is closed securely. The oven will not start cooking until the door is completely closed or the program has been reset.

Make sure the oven is properly installed and plugged into the electrical outlet.

WATTAGE OUTPUT CHART

- The power-level is set by pressing the POWER/DEFROST button. The chart shows the display, the power level and the percentage of power.

Press POWER/DEFROST button	Power level (Display)	Approximate Watts	%
once	P-HI	800 Watts	100%
twice	P-80	640 Watts	80%
3 times	P-60	480 Watts	60%
4 times	P-40	320 Watts	40%
5 times	P-20	160 Watts	20%

CONTROLS

SETTING THE CLOCK

When the oven is first plugged in, the display will flash “:0” and a tone will sound. If the AC power ever turns off, the display shows “:0” when the power comes back on.

CLOCK

1. Press CLOCK button.
This is a 12 hour clock system.
2. Press CLOCK button once more. This is a 24 hour clock system.
3. Turn the DIAL KNOB to adjust hour.

NOTE : This oven has multiple clock systems. If you want a 12 hour clock system, omit this step.

If you selected 12 hour system, the display will show the hours from “1” to “12”.
If you selected 24 hour system, the display will show the hours from “0” to “23”.
The adjusted hour starts blinking.

CLOCK

4. Press CLOCK button.
5. Turn the DIAL KNOB to adjust minute.

The hour stops blinking and “00” starts blinking.

The display will show the minutes from “0” to “59”.
The adjusted minute starts blinking.

CLOCK

6. Press CLOCK button.

When you press CLOCK button, the minute stops blinking, and the colon starts blinking. If you selected the 12 hour clock system, this digital clock allows you to set from 1:00 to 12:59. If you selected the 24 hour clock system, this digital clock allows you to set from 0:00 to 23:59.

WEIGHT DEFROSTING

WEIGHT DEFROST lets you easily defrost food by eliminating guesswork in determining defrosting time. The minimum weight for WEIGHT DEFROST is 200 gram and the maximum weight is 3,000 gram. Follow the steps below for easy defrosting.

DEFROST/
M/W

X 6

1. Press DEFROST/ M/W button.
Six times.
2. Turn the DIAL KNOB to adjust the defrosting weight.
3. Press START button.

The DEF. indicator & “0” appear and the g indicator starts blinking.

The display will show what you selected.

When you press START button, the g indicator disappears and the DEF. indicator starts blinking to show the oven is in the DEFROST mode. The display counts down the time to show you how much defrosting time is left in the DEFROST mode. The oven beeps during the defrosting cycle to signal that the food needs to be turned or rearranged. When the defrosting time ends, you will hear 3 beeps.

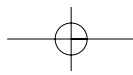

TIME DEFROSTING

When TIME DEFROST is selected, the automatic cycle divides the defrosting time into periods of alternating defrost and stand times by cycling on and off.

DEFROST/
M/W

X 7

1. Press DEFROST/ M/W button.
Seven times.

The DEF. indicator appears and “ : 0” is displayed.

2. Turn the DIAL KNOB to adjust
the defrosting time.

The display will show what you selected.

NOTE: Your oven can be programmed for
59 minutes 00 seconds. (59:00)

3. Press START button.

When you press the START button, the DEF. indicator starts blinking to show the oven is in the DEFROST mode. The display counts down the time to show you how much defrosting time is left in the DEFROST mode. The oven beeps during the defrosting cycle to signal that the food needs to be turned or rearranged. When the defrosting time ends, you will hear 3 beeps.

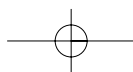



COOKING IN ONE STAGE

DEFROST/
M/W

1. Press DEFROST/ M/W button.
(Select the desired power level.)

The M/W indicator appears and the display will show what you selected.

NOTE: If step 1 is omitted, the oven will cook at full power.

2. Turn the DIAL KNOB to adjust the cooking time.

The display will show what you selected.

NOTE: Your oven can be programmed for 59 minutes 00 seconds.(59:00)

3. Press START button.

When you press START button, the M/W indicator starts blinking to show the oven is cooking. The display counts down the time to show how much cooking time is left. When the cooking time ends, you will hear 3 beeps.

NOTE: Using lower power levels increases the cooking time which is recommended for foods such as cheese, milk and slow cooking of meats.

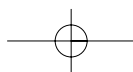

EASY COOKING

EASY COOK allows you to reheat for 30 seconds at 100% (full power) by simply pressing the EASY COOK button.

By repeatedly pressing the EASY COOK button, you can also extend reheating time to 5 minutes by intervals of 30 seconds.

EASY COOK

1. Press and hold EASY COOK button for 1 second.

When you press EASY COOK button, ":30" appears. After 1.5 seconds, the oven starts reheating. When the cooking time ends, you will hear 3 beeps.

AUTO COOK

AUTO COOK allows you to cook or reheat many of your favorite foods by repeatedly touching AUTO COOK button.

AUTO COOK

1. Press AUTO COOK button.

When you press AUTO COOK button once, "AC-1" is displayed. By repeatedly pressing this button, you can select one of the four menu programs as shown in the chart below.

2. Turn the DIAL KNOB to adjust the desired weight.

The display will show what you selected.

Food	Press AUTO COOK button	Display	Weight	Directions
Plated Dinner	once	AC-1	350g (12oz)	Put foods on the microwave plate and cover with vented plastic wrap.
			450g (15oz)	
Soup	twice	AC-2	350g (12oz)	Pour soup in microwave bowl or mug. Stir before serving.
			450g (15oz)	
Beverage	three times	AC-3	1 CUP (200ml)	Pour beverage in microwave mug and place it on the turntable. Do not cover. Stir before serving.
			2 CUPS (200mlx2)	
			3 CUPS (200mlx3)	
Fresh vegetable	four times	AC-4	200g (7oz)	Wash and put in casserole dish. Add no water if vegetables have just been washed. Cover tender vegetables with lid and stir after cooking.
			400g (14oz)	

3. Press START button.

When you press START button, the display changed into cooking time and the oven starts cooking. When the cooking time ends, you will hear 3 beeps.

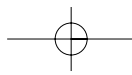

RADIO

This function allows you to listen to FM radio broadcasts from 87.5Mhz to 108Mhz.
For better reception, you should unfold the FM aerial wire.

NOTE: Bad reception or sound distortion may be subject to the place where the microwave oven is installed.

Tuning stations

RADIO

1. Press RADIO button.

If the radio function is selected the power led turns on. If you would like to switch the radio off, press the radio button again and the power led will go off.

2. Turn tuning knob to select the desired station.
The large vane on the knob, indicates the tuning point.

If a weak or distorted signal is being received, carefully turn the tuner knob again until the required station is clear.

NOTE: Weak reception can also be improved by moving the FM aerial wire to another position, However, please do not pull the aerial wire too strongly, as it is easily broken.

3. Turn volume knob to alter the level of the sound.

The volume knob serves as a comfortable volume control. Turn the knob clockwise to increase the volume and anticlockwise to decrease the volume.

NOTE: The radio does not function whilst the oven is cooking or defrosting. It will work again after cooking or defrosting has been completed.

NOTE: If you turn the dial knob or press any button except the 'RADIO' and 'STOP/CLEAR' while the radio is working, the radio pauses. The radio can be resumed by pressing the STOP/CLEAR button.

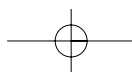

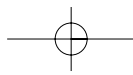

Setting the auto-start time of an FM radio broadcast

CLOCK	1. Set the CLOCK.	Refer to " SETTING THE CLOCK ".
	2. Press and hold CLOCK button for 3 seconds.	" : 0" appears on the display window. And PRESET indicator appears and a beep sounds.
	3. Press CLOCK button.	
CLOCK	4. Turn the DIAL KNOB to adjust hour.	
	5. Press CLOCK button.	
CLOCK	6. Turn the DIAL KNOB to adjust minute.	
	7. Press CLOCK button.	If you finish setting the auto-start time, it starts to go automatically. PRESET indicator will be blinking by the auto-start time and present time appears on the display window.

If you would like to check the auto-start time, press RADIO button. Then it will appear for 3 seconds. If you would like to cancel the auto-start time, press STOP/CLEAR button.

CHILD SAFETY LOCK

The SAFETY LOCK prevents unwanted oven operation such as by small children.

To set, press and hold the STOP/CLEAR button for 3 seconds, the LOCK indicator appears and a beep sounds.

To cancel, press and hold the STOP/CLEAR button for 3 seconds, the LOCK indicator disappears and a beep sounds.

TO STOP THE OVEN WHILE THE OVEN IS OPERATING

1. Press the STOP/CLEAR button.
 - You can restart the oven by pressing START button.
 - Press STOP/CLEAR button once more to erase all instructions.
 - You must enter in new instructions.
2. Open the door.
 - You can restart the oven by closing the door and pressing START button.

NOTE: The oven stops operating when door is opened.

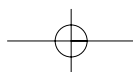

COOKING INSTRUCTIONS

Utensils should be checked to ensure that they are suitable for use in microwave ovens.

UTENSIL TEST	<p>Place the utensil in question next to a glass measure filled with water, in the microwave oven. Microwave at high power for 1-2 minutes. If the water heats up, but the utensil remains cool, the utensil is microwave-safe. However if the utensil becomes warm, microwaves are being absorbed by the utensil and it should not be in the microwave oven. You probably have many items on hand in your kitchen right now that can be used as cooking equipment in your microwave oven. Read through the following checklist.</p>
---------------------	--

COOKING UTENSILS

Recommended Use

Glass and glass-ceramic bowls and Dishes - Use for heating or cooking.

Microwave browning dish - Use to brown the exterior of small items such as steaks, chops, or pancakes. Follow the directions provided with you browning dish.

Microwaveable plastic wrap - Use to retain steam. Leave a small opening for some steam to escape and avoid placing it directly on the food.

Wax paper - Use as a cover to prevent spattering.

Paper towels, paper plates, napkins and cups - Use for short term heating and covering; they absorb excess moisture and prevent spattering. Always attend the oven closely. Only use to absorb fat and moisture when warming food. Pay special attention as over-heating may cause a fire in your oven. Do not use re-cycled paper products, e.g. kitchen roll unless they say they are specifically designed for use in a microwave oven. These products contain impurities which may cause sparks and/or fires when used.

Thermometers - Use only those labeled "Microwave Safe" and follow all directions. Check the food in several places. Conventional thermometers may be used once the food has been removed from the oven.

Microwave cling film, microwave roasting bags - Microwave cling film and bags must be vented for steam to escape, pierce in 4-5 places. Do not use plastic or metal ties as they may melt or catch fire due to electrical 'arcing'.

Limited Use

Aluminum foil - Use narrow strips of foil to prevent overcooking of exposed areas. Using too much foil can damage your oven, so be careful.

Ceramic, porcelain, and stoneware - Use these if they are labeled "Microwave Safe". If they are not labeled, test them to make sure they can be used safely. Never use dishes with metallic trim.

Plastic - Use only if labeled "Microwave Safe". Other plastics can melt.

Thin plastic, paper, straw and wooden containers - Always attend the oven closely. Look at the oven from time to time when cooking or reheating food in disposable containers of plastic, paper or other combustible material. Only use for warming food. Pay special attention as over-heating may cause a fire in your oven.

Not Recommended

Glass jars and bottles - Regular glass is too thin to be used in a microwave, and can shatter.

Paper bags - These are a fire hazard, except for popcorn bags that are designed for microwave use.

Styrofoam plates and cups - These can melt and leave an unhealthy residue on food.

Plastic storage and food containers - Containers such as margarine tubs can melt in the microwave.

Metal utensils - These can damage your oven. Remove all metal before cooking.

USE YOUR MICROWAVE OVEN SAFELY

General Use

Do not attempt to defeat or tamper with safety interlocks.

Do not place any object between the oven front frame and the door or allow residue to build up on sealing surfaces. Wipe with a mild detergent, rinse and dry. Never use abrasive powders or pads.

Do not subject the oven door to strain or weight such as a child hanging on an open door.

This could cause the oven to fall forward resulting in injury to you and damage to the oven.

Do not operate the oven if door seals or sealing surfaces are damaged; or if door is bent; or if hinges are loose or broken.

Do not operate the oven empty. This will damage the oven.

Do not attempt to dry clothes, newspapers or other materials in the oven. They may catch on fire.

Do not use recycled paper products as they may contain impurities which may cause sparks or fires.

Do not hit or strike the control panel with hard objects. This can damage the oven.

Food

Never use your microwave oven for home canning. The oven is not designed for proper home canning.

Improperly canned food may spoil and be dangerous to consume.

Always use the minimum recipe cooking time. It is better to undercook rather than overcook foods.

Undercooked foods can be returned to the oven for more cooking. If food is overcooked, nothing can be done.

Heat small quantities of food or foods with low moisture carefully. These can quickly dry out, burn or catch on fire.

Do not heat eggs in the shell. Pressure may build up and eggs can explode.

Potatoes, apples, egg yolks and sausages are examples of food with non-porous skins.

These must be pierced before cooking to prevent bursting.

Do not attempt to deep fat fry in your microwave oven.

Always stir liquids before heating. Heated liquids can erupt, if not mixed with air.

Do not leave the oven unattended while popping corn.

Do not pop corn in a paper bag unless it is the commercially prepared Microwave Popcorn product. The kernels can overheat and ignite a brown paper bag.

Do not put packaged Microwave Popcorn bags directly on the oven tray. Place the package on a microwave safe glass or ceramic plate to avoid overheating and cracking the oven tray.

Do not exceed the Microwave Popcorn manufacturers suggested popping time.

Longer popping does not yield more popcorn but it can result in scorch, burn of fire. Remember, the Popcorn bag and tray can be too hot to handle. Remove with caution and use pot holders.

CARE AND CLEANING

Although your oven is provided with safety features, it is important to observe following:

1. It is important not to defeat or tamper with safety interlocks.
2. Do not place any object between the oven front face and the door or allow residue to accumulate on sealing surfaces. Wipe the sealing area frequently with a mild detergent, rinse and dry. Never use abrasive powders or pads.
3. When opened, the door must not be subjected to strain, for example, a child hanging on an opened door or any load could cause injury and also damage to the door. Do not operate the oven if it is damaged, until it has been repaired by a trained service technician. It is particularly important that the oven closes properly and that there is no damage to the:
 - i) Door (bent)
 - ii) Hinges and Hookes (broken or loosened)
 - iii) Door seals and sealing surfaces.
4. The oven should not be adjusted or repaired by anyone except a properly trained service technician.

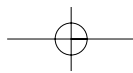

MICROWAVING PRINCIPLES

Microwave energy has been used in this country to cook and reheat food since early experiments with RADAR in World War II. Microwaves are present in the atmosphere all the time, both naturally and manmade sources. Manmade sources include radar, radio, television, telecommunication links and car phones.

HOW MICROWAVES COOK FOOD

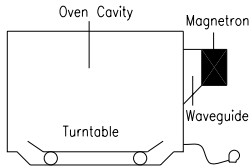

In a microwave oven, electricity is converted into microwave by the **MAGNETRON**.

► TRANSMISSION

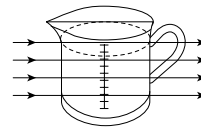

Then they pass through the cooking containers to be absorbed by the water molecules in the food, all foods contain water to a more or lesser extent.

► REFLECTION

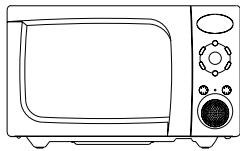

The microwaves bounce off the metal walls and the metal door screen.

► ABSORPTION

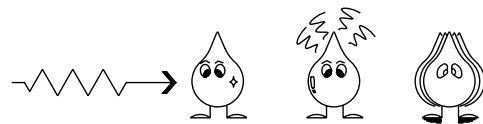

Microwave Water Molecule Absorption Vibration

The microwaves cause the water molecules to vibrate which causes **FRICTION**, i.e. **HEAT**. This heat then cooks the food. Microwaves are also attracted to fat and sugar particles, and foods high in these will cook more quickly. Microwaves can only penetrate to a depth of 1½ - 2 inches(4-5cm) and as heat spreads through the food by conduction, just as in a traditional oven, the food cooks from the outside inwards.

CONVERSION CHARTS

WEIGHT MEASURES	
15 g	½ oz.
25 g	1 oz.
50 g	2 oz.
100 g	4 oz.
175 g	6 oz.
225 g	8 oz.
450 g	1 lb.

VOLUME MEASURES	
30 ml	1 fl.oz.
100 ml	3 fl.oz.
150 ml	5 fl.oz. (¼ pt)
300 ml	10 fl.oz. (½ pt)
600 ml	20 fl.oz. (1pt)

SPOON MEASURES	
1.25 ml	¼ tsp
2.5 ml	½ tsp
5 ml	1 tsp
15 ml	1 tbsp

FLUID MEASUREMENTS		
1 Cup	= 8 fl.oz.	= 240 ml
1 Pint	= 16 fl.oz. (UK 20 fl.oz.)	= 480 ml (UK 560 ml)
1 Quart	= 32 fl.oz. (UK 40 fl.oz.)	= 960 ml (UK 1120 ml)
1 Gallon	= 128 fl.oz. (UK 160 fl.oz.)	= 3840 ml (UK 4500 ml)

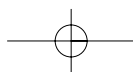

COOKING TECHNIQUES

STANDING TIME

Dense foods e.g. meat, jacket potatoes and cakes, require standing time(inside or outside of the oven) after cooking, to allow heat to finish conducting to cook the center completely. Wrap meat joints and jacket potatoes in aluminium foil while standing. Meat joints need approx. 10-15 minutes, jacket potatoes 5 minutes. Other foods such as plated meal, vegetables, fish etc require 2-5 minutes standing. After defrosting food, standing time should also be allowed. If food is not cooked after standing time, return to the oven and cook for additional time.

MOISTURE CONTENT

Many fresh foods e.g. vegetables and fruit, vary in their moisture content throughout the season, particularly jacket potatoes. For this reason cooking times may have to be adjusted. Dry ingredients e.g. rice, pasta, can dry out during storage so cooking times may differ.

DENSITY

Porous airy foods heat more quickly than dense heavy foods.

CLING FILM

Cling film helps keep the food moist and the trapped steam assists in speeding up cooking times. Pierce before cooking to allow excess steam to escape. Always take care when removing cling film from a dish as the build-up of steam will be very hot.

SHAPE

Even shapes cook evenly. Food cooks better by microwave when in a round container rather than square.

SPACING

Foods cook more quickly and evenly if spaced apart. NEVER pile foods on top of each other.

STARTING TEMPERATURE

The colder the food, the longer it takes to heat up. Food from a fridge takes longer to reheat than food at room temperature.

LIQUIDS

All liquids must be stirred before and during heating. Water especially must be stirred before and during heating, to avoid eruption. Do not heat liquids that have previously been boiled. DO NOT OVERHEAT.

TURNING & STIRRING

Some foods require stirring during cooking. Meat and poultry should be turned after half the cooking time.

ARRANGING

Individual foods e.g. chicken portions or chops, should be placed on a dish so that the thicker parts are towards the outside.

QUANTITY

Small quantities cook faster than large quantities, also small meals will reheat more quickly than large portions.

PIERCING

The skin or membrane on some foods will cause steam to build up during cooking. These foods must be pierced or a strip of skin should be peeled off before cooking to allow the steam to escape. Eggs, potatoes, apples, sausages etc, will all need to be pierced before cooking. DO NOT ATTEMPT TO BOIL EGGS IN THEIR SHELLS.

COVERING

Cover foods with microwave cling film or a lid. Cover fish, vegetables, casseroles, soups. Do not cover cakes, sauces, jacket potatoes or pastry items.



DEFROSTING GUIDE

- Do not defrost covered meat. Covering might allow cooking to take place. Always remove outer wrap and tray. Use only containers that are microwave-safe.
 - Begin defrosting whole poultry breast-side- down. Begin defrosting roasts fat-side-down.
 - The shape of the package alters the defrosting time. Shallow rectangular shapes defrost more quickly than a deep block.
 - After $\frac{1}{3}$ of the defrost time has elapsed, check the food. You may wish to turn over, break apart, rearrange or remove thawed portions of the food.
 - During defrost, the oven will prompt you to turn the over. At this point, open oven door and check the food. Follow the techniques listed below for optimum defrost results. Then, close oven door, touch the START pad to complete defrosting.
 - When defrosted, food should be cool, but softened in all areas. If still slightly icy, return to microwave oven very briefly, or let stand a few minutes. After defrosting, allow food to stand 5-60 minutes if there are any icy areas.
Poultry and fish may be placed under running cool water until defrosted
- ⇒ **Turn over** : Roast, ribs, whole poultry, turkey breasts, hot dogs, sausages, steaks, or chops.
- ⇒ **Rearrange** : Break apart or separate steaks, chops, hamburger patties, ground meat, chicken or seafood pieces, chunks of meat such as stew beef.
- ⇒ **Shield** : Use small strips of aluminum foil to protect thin areas or edges of unevenly shaped foods such as chicken wings. To prevent arching, do not allow foil to come within 1-inch of oven walls or door.
- ⇒ **Remove** : To prevent cooking, thawed portions should be removed from the oven at this point. This may shorten defrost time for food weighing less than 3 lbs.(1350g).

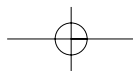

DEFROSTING CHART

Item and Weight	Defrosting Time	Standing Time	Special Techniques
BEEF Minced beef 1 lb./454g	10-12 min.	15-20 min.	Break apart and remove thawed portions with fork.
Stew Meat 1 ¹ / ₂ lbs./675g	9-11 min.	25-30 min.	Separate and rearrange once.
Loin Roast 2 lbs./900g	15-18 min.	45-60 min.	Turn over after half the time. Shield as needed.
Patties 4 (4 oz./110g)	7-8 min.	15-20 min.	Turn over after half the time.
PORK Loin Roast 2 lbs./900g	15-16 min.	45-60 min.	Turn over after half the time. Shield as needed.
Spareibs 1 lb. 450g	6-7 min.	25-30 min.	Separate and rearrange once.
Chops 4 (5 oz./125g)	7-8 min.	25-30 min.	Separate and turn over once.
Minced 1lb./450g	9-10 min.	15-20 min.	Break apart and remove thawed portions with fork.
POULTRY Whole Chicken 2 ¹ / ₂ lbs./1125g	20-22 min.	45-90 min.	Break side down. Turn over after half the time. Shield as needed.
Chicken Breasts 1lb./450g	9-10 min.	15-30 min.	Separate and rearrange once.
Fryer Chicken(cut up) 2lbs./900g	12-14 min.	25-30 min.	Separate and rearrange once.
Chicken Thighs 1 ¹ / ₂ lbs./675g	12-14 min.	15-30 min.	Separate and rearrange once.
FISH & SEAFOOD Whole Fish 1lb./450g	6-7 min.	15-20 min.	Turn over after half the time. Shield as needed.
Fish Fillets 1 ¹ / ₂ lb./675g	7-8 min.	15-20 min.	Separate and turn over once.
Shrimp 1/2 lb./225g	3-4 min.	10-15 min.	Separate and rearrange once.

* The times are approximate because freezer temperatures vary.

COOKING & REHEATING CHART

Item	Power Level	Cooking Time Per lb./g		
MEAT				
Beef				
Standing / rolled Rib - Rare	P-80	9-11 min.		
- Medium	P-80	10-12 min.		
- well done	P-80	12-14 min.		
Ground Beef (to brown for casserole)	P-HI	5-7 min.		
Hamburgers, Fresh or defrosted				
(4oz. Each/100g) 2 patties	P-HI	3-5 min.		
4 patties	P-HI	4-6 min.		
Pork				
Loin, Leg	P-80	13-16 min.		
Bacon 4 slices	P-HI	2-3 min.		
6 slices	P-HI	3-4 min.		
NOTE: The above times should be regarded only as a guide, Allow for difference in individual lasts and preferences. The times may vary due to the shape, cut, and composition of the meat.				
POULTRY				
Chicken				
Whole	P-HI	8-10 min.		
Breast(boned)	P-80	6-8 min.		
portions	P-80	7-9 min.		
Turkey				
Whole	P-HI	10-12 min.		
NOTE : The above times should be regarded only as a guide. Allow for difference in individual tastes and preferences. The times may vary due to the shape, cut, and composition of the food.				
FRESH FISH				
Item	Power Level	Cooking Time Per lb./g	Method	Standing Time
Fish Fillets	P-HI	4-6 min.	Add 15-30 ml(1-2 Tbsp)	2-3 min.
Whole Mackerel, Cleaned and Prepared	P-HI	4-6 min.	-	3-4 min.
Whole Trout, Cleaned and Prepared	P-HI	5-7 min.	-	3-4 min.
Salmon Steaks	P-HI	5-7 min.	Add 15-30 ml(1-2 Tbsp)	3-4 min.
ITEM	POWER LEVEL	Cooking Time	Standing Time	
Lasagna 1 serving(10 1/2 oz./300g)	P-HI	5-7 min.	Place lasagna on microwaveable plate. Cover with plastic wrap and vent.	
Casserole 1 cup	P-HI	1 1/2 -3 min.	Cook covered in microwaveable casserole.	
4 cups	P-HI	5-7 min.	Stir once halfway through cooking.	
Mashed potatoes 1 cup	P-HI	2-3 min.	Cook covered in microwaveable casserole.	
4 cups	P-HI	6-8 min.	Stir once halfway through cooking.	
Baked beans 1 cup	P-HI	2-3 min.	Cook covered in microwaveable casserole. Stir once halfway through cooking.	



ITEM	POWER LEVEL	Cooking Time	Standing Time
Ravioli or pasta in sauce 1 cup 4 cups	P-HI P-HI	3-4 min. 8-11 min.	Cook covered in microwaveable casserole. Stir once halfway through cooking.
Sandwich roll or bun 1 roll	P-HI	20-30 sec.	Wrap in paper towel and place on glass microwaveable rack * Note : Do not use recycled paper towels.

VEGETABLE CHART

* Note : Use power level High (P-HI) unless otherwise noted.

VEGETABLES	AMOUNT	TIME	SPECIAL INSTRUCTIONS
Asparagus			
Fresh spears	1 lb./450g	5-8 min.	In medium casserole, place 1/4 cup water.
Frozen spears	10-oz./280g package	4-7 min.	In medium casserole.
Beans			
Fresh green	1 lb./450g cut in half	10-15 min.	In medium casserole, place 1/2 cup water.
Frozen green	10-oz./280g package	5-8 min.	In medium casserole, place 2 tbsp water.
Frozen lima	10-oz./280g package	4-7 min.	In medium casserole, place 1/4 cup. Water.
Beets			
Fresh, whole	1 bunch(1 1/4 -1 1/2 lbs.) /560-680g	16-22 min.	In medium casserole, place 1/2 cup water.
Broccoli			
Fresh cut	1 bunch(1 1/4 -1 1/2 lbs.) /560-680g	5-9 min.	In large casserole, place 1/2 cup water.
Fresh spears	1 bunch(1 1/4 -1 1/2 lbs.) /560-680g	7-11 min.	In large casserole, place 1/2 cup water.
Frozen, chopped	10-oz./280g package	4-7 min.	In medium casserole.
Frozen spears	10-oz./280g package	4-7 min.	In medium casserole, place 3 tbsp water.
Cabbage			
Fresh Wedges	1 medium head (about 2 lbs./900g)	6-10 min. 5-9 min.	In large casserole, place 1/4 cup water. In large casserole, place 1/4 cup water.
Carrots			
fresh, sliced	1 lb./450g	4-8 min.	In large casserole, place 1/2 cup water.
frozen	10-oz./280g package	4-7 min.	In medium casserole, place 2 tbsp water.
Cauliflower			
flowerets	1 medium head (about 2 lbs./900g)	7-11 min.	In large casserole, place 1/2 cup water.
fresh, whole	1 medium head (about 2 lbs./900g)	7-15 min.	In large casserole, place 1/2 cup water.
frozen	10-oz./280g package	3-7 min.	In medium casserole, place 2 tbsp water.
Corn			
frozen kernel	10-oz./280g package	2-6 min.	In medium casserole, place 2 tbsp water.
Corn on the cob			
fresh	1-5 ears	(per ear) 1 1/4 -4min.	In large glass baking dish, place corn. If corn is in husk, use no water; if corn has been husked, add 1/4 cup water. Rearrange after half of time.
frozen	1 ear 2-6 ears	3-6 min. 2-3 min.	Place in large oblong glass baking dish. Cover with vented plastic wrap. Rearrange after half of time.

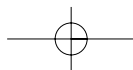

VEGETABLES	AMOUNT	TIME	SPECIAL INSTRUCTIONS
Mixed vegetable frozen	10-oz./280g package	2-6 min.	In medium casserole, place 3 tbsp water.
Peas fresh, shelled	2 lbs.(450g) unshelled	7-10 min.	In medium casserole, place 1/4 cup water.
frozen	10-oz.(280g) package	2-6 min.	In medium casserole, place 2 tbsp water.
Potatoes fresh, cubed, white	4 potatoes (6-8 oz. /160-220g each)	9-12 min.	Peel and cut into 1-inch cubes. Place in large casserole with 1/2 cup water. Stir after half of time.
fresh, whole, sweet or white	1 (6-8 oz./160-220g)	2-4 min.	Pierce with cooking fork. Place in the oven, 1-inch apart, in circular arrangement. Let stand 5 minutes.
Spinach fresh	10-16 oz./280-450g	3-6 min.	In large casserole, place washed spinach.
frozen, chopped, and leaf	10-oz./280g package	3-6 min.	In medium casserole, place 3 tbsp water.
Squash fresh, summer, and yellow	1 lb./450g sliced.	3-5 min.	In large casserole, place 1/4 cup water. Cut in half and remove fibrous membranes.
winter, acorn, or butternut	1-2 squash (about 1 lb./450g each)	5-9 min.	In large glass baking dish, place squash cut-side-down. Turn cut-side-up after 4 minutes.

TOMATO & ORANGE SOUP

1 oz.(25g) butter
 1 medium onion, chopped
 1 large carrot & 1 large potato, chopped
 1³/₄lb(800g) canned, chopped tomatoes
 juice and grated rind of 1 small orange
 1¹/₂pints(900ml) hot vegetable stock
 salt and pepper to taste

1. Melt the in a large bowl on P-HI for 1 minute.
2. Add the onion, carrot and potato and cook on P-HI for 6 minutes. stir halfway through cooking.
3. Add the tomatoes, orange juice, orange rind and stock. Mix thoroughly. Season with salt and pepper to taste. Cover the bowl and cook on P-HI for 18 minutes. stir 2-3 times during cooking, until the vegetables are tender.
4. Blend and serve immediately.

FRENCH ONION SOUP

1 large onions, sliced
 1 tbsp (15ml) corn oil
 2 oz.(50g) plain flour
 2 pints(1.2 liters) hot meat
 or vegetable stock
 salt and pepper to taste
 2 tbsp (30ml) parsley, chopped
 4 thick slices French bread
 2 oz.(50g) cheese, grated

1. Place the onion and oil a bowl, mix well and cook on P-HI for 2 minutes.
2. Stir in the flour to make a paste and gradually add stock. Season and add the parsley.
3. Cover the bowl and cook on P-80 for 20 minutes.
4. Pour the soup into serving bowls, submerge bread and sprinkle generously with cheese.
5. Cook on P-80 for 2 minutes, until the cheese has melted.

STIR FRIED VEGETABLES

1 tbsp(15ml) sunflower oil
 2 tbsp (30ml) soy sauce
 1 tbsp (15ml) sherry
 1"(2.5cm) root ginger,
 peeled and finely grated
 2 medium carrots, cut into fine strips
 4 oz.(100g) button mushrooms,
 chopped
 2 oz.(50g) beansprouts
 4 oz.(100g) mange-tout
 1 red pepper, seeded and thinly sliced
 4 spring onions, chopped
 4 oz.(100g) canned water chestnuts,
 sliced
 1/4 head of chinese leaves, thinly sliced

1. Place the oil, soy sauce, sherry, ginger, garlic and carrots in a large bowl, mix thoroughly
2. Cover and cook on P-HI for 5-6 minutes, stirring once.
3. Add the button mushrooms, beansprouts, mange-tout, red pepper, spring onions, water chestnuts and chinese leaves. Mix thoroughly.
4. Cook on P-HI for 6-7 minutes, until the vegetables are tender. Stir 2-3 times during cooking.

Stir fried vegetables are ideally served with meat or fish.

HONEYED CHICKEN

4 boneless chicken breasts
 2 tbsp(30ml) clear honey
 1 tbsp(15ml) whole grain mustard
 1/2 tsp(2.5ml) dried tarragon
 1 tbsp(15ml) tomato puree
 1/4 pint(150ml) chicken stock

1. Place the chicken breasts in a casserole dish.
2. Mix all remaining ingredients together and pour over the chicken. Salt and pepper to taste.
3. Cook on P-HI for 13-14 minutes. Rearrange and coat the chicken with the sauce twice during cooking.

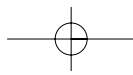

BLUE CHEESE & CHIVE JACKETS

2 baking potatoes,
(approx.9 oz.(250g) each)
2 oz.(50g) butter
4 oz.(100g) blue cheese, chopped
1 tbsp(15ml) fresh chives, chopped
2 oz.(50g) mushrooms, sliced
salt and pepper to taste

1. Prick each potato in several places. Cook on P-HI for 12-13 minutes. Halve and scoop the flesh into a bowl, add the butter, cheese, chives, mushrooms, salt and pepper, mix thoroughly.
2. Pile mixture into the potato skins and place in a flan dish, on the rack.
3. Cook on P-60 for 10 minutes.

WHITE SAUCE

1 oz.(25g) butter
1 oz.(25g) plain flour
1/2 pint(300ml) milk
salt and pepper to taste

1. Place the butter in a bowl and cook on P-HI for 1 minute, until melted.
2. Stir in the flour and whisk in the milk. Cook on P-HI for 4-5 minutes, stirring every 2 minutes until thick and smooth. Season with salt and pepper to taste.

STRAWBERRY JAM

1 1/2 lb.(675g) strawberries, hulled
3 tbsp(45ml) lemon juice
1 1/2 lb.(675g) caster sugar

1. Place strawberries and lemon juice in a very large bowl, heat on P-HI for 5 minutes, or until the fruit has softened. Add sugar, mix well.
2. Cook on P-80 for 30-35 minutes, until setting point*is reached, stir every 4-5 minutes.
3. Pour into hot, clean jars. Cover, seal and label.

** setting point : To determine setting point, place 1 tsp(5ml)jam onto chilled saucer. Allow to stand for 1 minute. Move surface of jam gently with your finger, if the surface wrinkles setting point has been reached.*

PLAIN MICROWAVE CAKE

4 oz.(100g) margarine
4 oz.(100g) sugar
1 eggs
4 oz.(100g) self raising flour, sifted
2-3 tbsp(30-45ml) milk

1. line the base of 8" (20.4cm) cake dish with grease-proof paper.
2. Cream the margarine and sugar together until light and fluffy. Beat in the eggs and fold in the sifted flour alternately with the milk.
3. Pour into prepared container. Cook on P-HI for 4-5 minutes, until a skewer comes out cleanly.
4. Leave the cake to stand for 5 minutes before turning out.

OMELETTES

1/2 oz.(15g) butter
4 eggs
6 tbsp(90ml) milk
salt & pepper

1. Whisk together eggs and milk. Season.
2. Place butter in 10"(26cm) flan dish. Cook on P-HI for 1 minute, until melted. Coat the dish with the melted butter.
3. Pour omelette mixture into flan dish. Cook on P-HI for 2 minutes. whisk mixture and cook again on P-HI for 1 minutes.

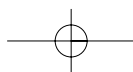

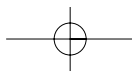

SCRAMBLED EGG

1/2 oz.(15g) butter
2 eggs
2 tbsp(30ml) milk
salt & pepper

1. Melt the butter in a bowl on P-HI for 1 minutes.
2. Add the eggs, milk and seasoning and mix well.
3. Cook on P-HI for 3 minutes, stirring every 30 seconds.

SAVORY MINCE

1 small onion, diced
1 clove garlic, crushed
1 tsp(5ml) oil
7 oz.(200g) can chopped tomatoes
1 tbsp(15ml) tomato puree
1 tsp(5ml) mixed herbs
8 oz.(225g) minced beef
salt and pepper

1. Place onion, garlic and oil in casserole, and cook on P-HI for 2 minutes or until soft.
2. Place all other ingredients in casserole. Stir well.
3. Cover and cook on P-HI for 5 minutes then P-60 for 10-15 minutes or until the meat is cooked.

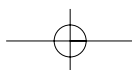
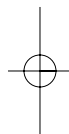
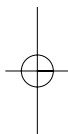



BEFORE YOU CALL FOR SERVICE

Refer to the following checklist, you may prevent an unnecessary service call.

- * The oven doesn't work;
 1. Check that the power cord is securely plugged in.
 2. Check that the door is firmly closed.
 3. Check that the cooking time is set.
 4. Check for a blown circuit fuse or tripped main circuit breaker in your house.
- * Sparking in the cavity;
 1. Check utensils. Metal containers or dishes with metal trim should not be used.
 2. Check that metal skewers or foil does not touch the interior walls.

If there is still a problem, contact the service station.
A list of these stations is included in the oven.

DO NOT ATTEMPT TO SERVICE THE OVEN YOURSELF !

QUESTIONS AND ANSWERS

- * **Q** : I accidentally ran my microwave oven without any food in it. Is it damaged?
A : Running the oven empty for a short time will not damage the oven. However, it is not recommended.
- * **Q** : Can the oven be used with the glass tray or roller guide removed?
A : No. Both the glass tray and roller guide must always be used in the oven before cooking.
- * **Q** : Can I open the door when the oven is operating?
A : The door can be opened anytime during the cooking operation. Then microwave energy will be instantly switched off and the time setting will maintain until the door is closed and START is touched.
- * **Q** : Why do I have moisture in my microwave oven after cooking?
A : The moisture on the side of your microwave oven is normal. It is caused by steam from cooking food heating the cool oven surface.
- * **Q** : Dose microwave energy pass through the viewing screen in the door?
A : No. The metal screen bounces back the energy to the oven cavity. The holes are made to allow light to pass through. They do not let microwave energy pass through.
- * **Q** : Why do eggs sometimes pop?
A : When baking or piaching eggs, the yolk may pop due to steam build-up inside the yolk membrane. To prevent this, simply pierce the yolk with a toothpick before cooking. Never cook eggs without piercing their shells.
- * **Q** : Why this standing time recommended after the cooking operation has been completed?
A : Standing time is very important.
With microwave cooking, the heat is in the food, not in the oven. Many foods build up enough internal heat to allow the cooking process to continue, even after the food is removed from the oven. Standing time for joints of meat, large vegetables and cakes is to allow the inside to cook completely, without overcooking the outside.

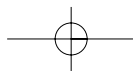

QUESTIONS AND ANSWERS (continued)

* **Q** : What does “standing time” mean?

A : “Standing time” means that food should be removed from the oven and covered for additional time to allow it to finish cooking. This frees the oven for other cooking.

* **Q** : Why does my oven not always cook as fast as the microwave cooking guide says?

A : Check your cooking guide again, to make sure you've followed directions exactly ; and to see what might cause variations in cooking time. Cooking guide times and heat settings are suggestions, to help prevent over-cooking... the most common problem in getting used to a microwave oven. Variations in the size, shape and weights and dimensions could require longer cooking time. Use your own judgement along with the cooking guide suggestions to check whether the food has been properly cooked just as you would do with a conventional cooker.

* **Q** : Will the microwave oven be damaged if it operates while empty?

A : Yes. Never run it empty.

* **Q** : Can I operate my microwave oven without the turntable or turn the turntable over to hold a large dish?

A : No. If you remove or turn over the turntable, you will get poor cooking results. Dishes used in your oven must fit on the turntable.

* **Q** : Is it normal for the turntable to turn in either direction?

A : Yes. The turntable rotates clockwise or counterclockwise, depending on the rotation of the motor when the cooking cycle begins.

* **Q** : Can I pop popcorn in my microwave oven? How do I get the best results?

A : Yes. Pop packaged microwave popcorn following manufacture's guidelines or use the preset POPCORN pad. Do not use regular paper bags. Use the “listening test” by stopping the oven as soon as the popping slows to a “pop” every 1 or 2 seconds. Do not repop unpopped kernels. Do not pop popcorn in glass cookware.

DAEWOO ELECTRONICS SALES UK LIMITED

YOUR PRODUCT GUARANTEE

Dear Customer,

Thank you for buying this Daewoo product. In the unlikely event of a failure all repair work will be carried out by your retailer or Daewoo approved service centre, for a period of 12 months from date of sale.

Daewoo Electronics Sales UK Ltd., will provide the following services in order to expedite this guarantee.

During this period should a fault occur due to improper materials or workmanship, the retailer, authorised service centre, or authorised service dealer will carry out repairs at no cost to yourself. Replacement products will be offered at the discretion of your supplying dealer.

This guarantee will be honoured by Daewoo service networks in other E.C. members states, in accordance with the terms and conditions which prevail in the member state at the time service is requested.

CONDITIONS

Any claims made under the terms of the guarantee must be supported by the original invoice/bill of sale issued at the time of sale. Daewoo reserve the right to refuse guarantee should any of the information on the bill of sale be removed or changed in any way after the original purchase of the product by the consumer from the retailer.

Modifications or adjustments made to the product which enable it to conform to local technical or safety standards in force in any country other than the one for which the product was originally designed and manufactured, are not included in this guarantee. Failures arising from such modifications, whether performed properly or not, will not be covered by this guarantee.

THIS GUARANTEE DOES NOT COVER ANY OF THE FOLLOWING:-

- 1) Periodic maintenance, the repair or replacement of parts due to normal wear and tear.
- 2) Home service transport cost, and other costs and risks of transport relating directly or indirectly to the guarantee of the product.
- 3) Damage to this product resulting from: the above and misuse, including but not limited to the failure to use this product for its normal purpose or in accordance with the instructions on the proper use and maintenance of this product, and the installation or the use of this product in a manner inconsistent with the technical or safety standards in force in the country where the product is used.
- 4) Repairs carried out by non-authorised service centres.
- 5) Accidents, acts of God, or any cause beyond the control of Daewoo including but not limited to lightning, water, fire and improper ventilation.
- 6) Aerial alignment and consumer control adjustments
- 7) Batteries whether supplied by Daewoo or not which become worn or exhausted in use.
- 8) Loss or damage caused to any item or article used with this product. This includes (but not limited to) discs, tapes, records, and films.

This guarantee does not affect your statutory rights as a consumer, nor your rights against the retailer, arising from their sales or purchase contract.

In the absence of applicable legislation, this guarantee will be the consumers sole and exclusive remedy, and neither Daewoo nor its subsidiary, or distributor shall be liable for any incidental or consequential damages for breach of any express or implied guarantee of this product.

For further information regarding this or any other query you may have about Daewoo products or its services please write to:-

Daewoo Electronics Sales UK Limited
Daewoo Building
Wharfdale Road
Winnersh Triangle
Workingham
Berkshire RG11 5TP

**IN ALL CASES OF DIFFICULTY-CONSULT YOUR DAEWOO
DEALER FROM WHOM THE PRODUCT WAS PURCHASED**